

**Power PCB Relay RT1 Inrush Power**

- 1 pole 16A, 1 form A (NO) contact (W pre-make contact + AgSnO<sub>2</sub>)
- 165A/20ms inrush peak current
- Mono- or bistable coil
- 5kV/10mm coil-contact
- Reinforced insulation
- Test tab (manual operator) optional
- WG version: product in accordance to IEC60335-1

Typical applications

Lighting systems, movement sensors, filament and incandescent lamp loads, motors.



**Approvals**

VDE Cert. No. 40007571, UL E214025, cCSAus 1142018  
Technical data of approved types on request.

Contact Data	RT.3T	RTS3L
Contact arrangement	1 form A (NO) contact	
Rated voltage	250VAC	
Max. switching voltage	400VAC	
Rated current	16A	
Limiting continuous current	16A, UL: 20A (RTS3L)	
Limiting making current, max. 20ms (incand. lamps)	165A	120A
Breaking capacity max.	4000VA	
Contact material	W (pre-make cont.)	AgSnO <sub>2</sub>
Contact style	pre-make contact	single contact
Frequency of operation, with/without load	360/3600h <sup>-1</sup>	
Operate/release time max., DC coil	10/5ms	
Operate/Reset time max., bistable version	10/10ms	
Bounce time max.	4ms	

**Contact ratings**

Type	Contact	Load	Cycles
<b>IEC 61810</b>			
RTS3L	A (NO)	20A, 250VAC resistive, 70°C	20x10 <sup>3</sup>
RTS3L monostable A (NO)	16A, 250VAC resistive, 85°C		100x10 <sup>3</sup>
RTS3T	A (NO)	16A, 250VAC resistive, 85°C	5x10 <sup>3</sup>
<b>UL 508</b>			
RTS3L	A (NO)	20A, 250VAC, general purpose, 70°C	20x10 <sup>3</sup>
RTS3L	A (NO)	16A, 250VAC, resistive, 85°C	50x10 <sup>3</sup>
RTS3L	A (NO)	TV8, 240VAC, 40°C	25x10 <sup>3</sup>
RTS3L	A (NO)	1.5hp, 240VAC, 70°C	30x10 <sup>3</sup>
RTS3T	A (NO)	1200W Tungsten, 120VAC/277VAC, 60Hz, 50°C	6x10 <sup>3</sup>
RTS3T	A (NO)	620W Discharge lamps (standard ballast), 120VAC/277VAC, 60Hz, 50°C	6x10 <sup>3</sup>

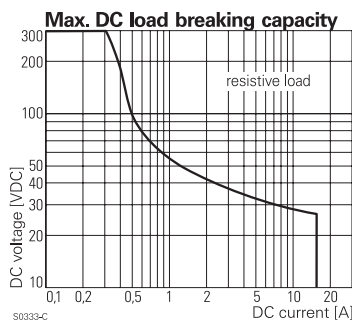

**Contact Data (continued)**

Mechanical endurance		
DC coil	>5x10 <sup>6</sup> ops.	>10x10 <sup>6</sup> ops.
bistable version	>3x10 <sup>6</sup> ops.	>5x10 <sup>6</sup> ops.
tab manually operated	>1x10 <sup>3</sup> ops.	-

**Coil Data, monostable DC coil**

Coil voltage range	5 to 110VDC
Operative range, IEC 61810	2
Coil insulation system according UL1446	class F

**Coil versions, monostable DC coil**

Coil code	Rated voltage VDC	Operate voltage VDC	Release voltage VDC	Coil resistance Ω±10% <sup>1)</sup>	Rated coil power mW
005	5	3.5	0.5	62	403
006	6	4.2	0.6	90	400
009	9	6.3	0.9	203	400
012	12	8.4	1.2	360	400
024	24	16.8	2.4	1440	400
048	48	33.6	4.8	5520	417
060	60	42.0	6.0	8570 <sup>1)</sup>	420
110	110	77.0	11.0	28800 <sup>1)</sup>	420

1) Coil resistance ±12%.

All figures are given for coil without pre-energization, at ambient temperature +23°C. Other coil voltages on request.

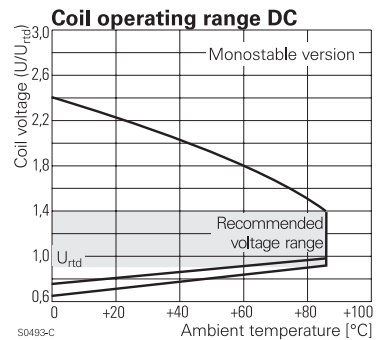

**Coil Data, bistable coils**

	1 coil	2 coils
Magnetic system	polarized, bistable	
Coil voltage range	3 to 24VDC	
Operative range, IEC 61810	2	
Limiting voltage, % of rated coil voltage	120%	150%
Min./Max. energization duration	30ms/1min at <10% duty factor	
Coil insulation system according UL1446	class F	

**Power PCB Relay RT1 Inrush Power** (Continued)

**Coil Data** (continued)

**Coil versions, bistable**

Coil code	Rated voltage VDC	Set voltage VDC	Reset voltage VDC	Coil resistance $\Omega \pm 10\%$	Rated coil power mW
A03	3	2.1	1.7	21	429
A12	12	8.4	6.6	360	400
A24	24	16.8	13.2	1440	400

**Coil versions, bistable 1 coil**

A03	3	2.1	1.7	21	429
A12	12	8.4	6.6	360	400
A24	24	16.8	13.2	1440	400

**Coil versions, bistable 2 coils**

F03	3	2.1	1.7	15	600
F12	12	8.4	6.6	240	600
F24	24	16.8	13.2	886	650

All figures are given for coil without pre-energization, at ambient temperature +23°C. Other coil voltages on request.

**Bistable coils - operation**

Version	1 coil		2 coils		
Coil terminals	A1	A2	A1	A3	A2
Operate	+	-	-	+	-
Reset	-	+	-	+	-

Contact position not defined at delivery

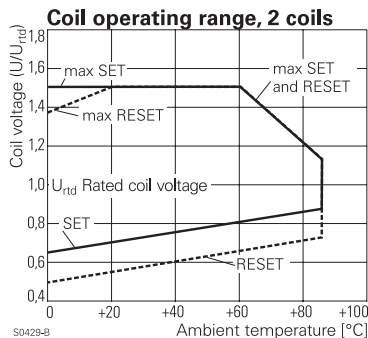
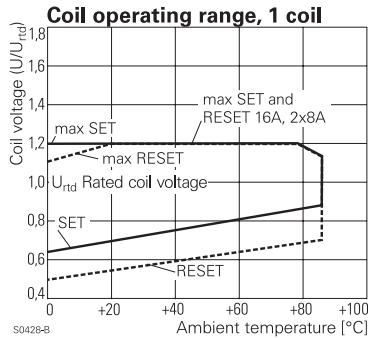

**Insulation Data**

Initial dielectric strength	
between open contacts	1250V <sub>rms</sub>
between contact and coil	5000V <sub>rms</sub>
Clearance/creepage	
between contact and coil	≥10/10mm
Material group of insulation parts	IIIa
Tracking index of relay base	PTI 250V

**Other Data**

Material compliance: EU RoHS/ELV, China RoHS, REACH, Halogen content refer to the Product Compliance Support Center at [www.te.com/customer-support/rohssupportcenter](http://www.te.com/customer-support/rohssupportcenter)

	RT.3T	RTS3L
Ambient temperature		
monostable DC coil		-40 to 85°C
bistable 1 coil		-10 to 85°C
bistable 2 coils		-40 to 85°C
Category of environmental protection		
IEC 61810		RTII - flux proof
Vibration resistance (functional), monostable version	10g	20g
Shock resistance (destructive)		100g
Terminal type	PCB-THT, plug-in <sup>2)</sup>	
Weight, without / with test tab	14/16g	14g/-
Resistance to soldering heat THT	270°C/10s	
IEC 60068-2-20		
Packaging/unit		
without test tab	tube/20 pcs., box/500 pcs.	tube/20 pcs., box/500 pcs.
with test tab	tray/25 pcs., box/100 pcs.	- -

2) RTT3T or bistable 2 coil version: PCB mounting only. See Accessories.

**Accessories RTS3.**

For details see datasheet [Accessories Industrial Power Relay RT](#)

Socket available for 1 coil version only.

NOTE: indicated contact ratings and electrical endurance data for direct wiring of relays (according IEC 61810-1); for relays mounted on sockets deratings may apply.

**Power PCB Relay RT1 Inrush Power** (Continued)

**Terminal assignment**

Bottom view on solder pins

monostable version

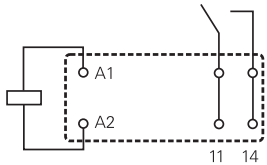

bistable version

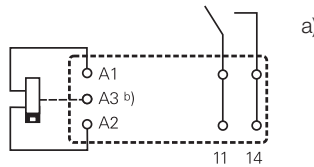

a) Indicated contact position during or after coil energization with reset voltage.

b) for 2 coil version only

**Dimensions / PCB layout**

version without test tab

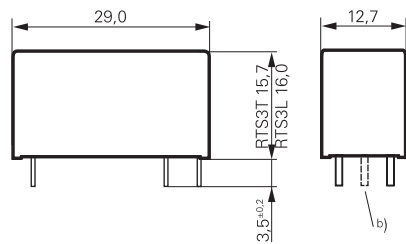

S0272-BW

16A, pinning 5mm

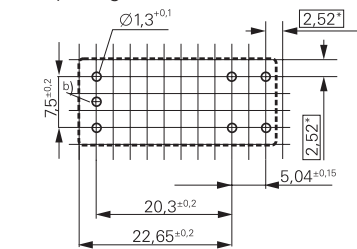

b) for 2 coil version only

version with test tab

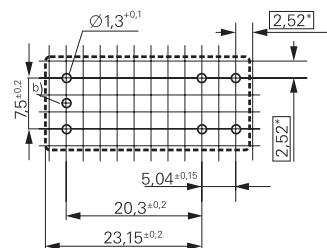
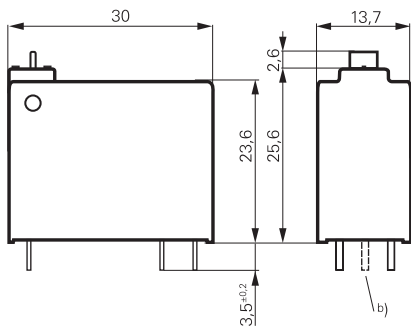
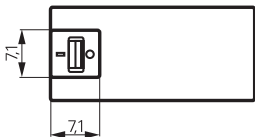

\*) With the recommended PCB hole sizes a grid pattern from 2.5mm to 2.54mm can be used.

**Power PCB Relay RT1 Inrush Power** (Continued)

<b>Product code structure</b>		Typical product code				<b>RT</b>	<b>S</b>	<b>3</b>	<b>T</b>	<b>A12</b>
<b>Type</b>	<b>RT</b>	Power PCB Relay RT1 Inrush Power								
<b>Version</b>	<b>S</b>	Without test tab	<b>T</b>	With test tab (manual operator) for contact material ,T' and bistable coil only						
<b>Contact configuration</b>	<b>3</b>	1 form A (NO) contact								
<b>Contact material</b>	<b>L</b>	AgSnO <sub>2</sub>	<b>T</b>	Tungsten (W) pre-make + AgSnO <sub>2</sub>						
<b>Coil</b>	Coil code: please refer to coil versions table									
<b>Version</b>	<b>Blank</b>	Standard Version								
	<b>WG</b>	Product in accordance to IEC 60335-1								

Product code	Version	Contacts	Contact material	Coil version	Coil	Version	Part number				
RTS3L005	Without test tab, 16mm high	1 form A (NO) contact	AgSnO <sub>2</sub>	Monostable	5VDC	Standard	1-1415898-8				
RTS3L006					6VDC		4-1415898-4				
RTS3L012	Without test tab, 15.7mm high		W pre-make + AgSnO <sub>2</sub>	Monostable	12VDC		1-1415898-9				
RTS3L024					24VDC		1-1415898-4				
RTS3LA12					Bistable, 1 coil		12VDC	2-1415898-3			
RTS3LF12					Bistable, 2 coils			2-1415898-5			
RTS3T005					5VDC		1-1415898-6				
RTS3T012					12VDC		1415898				
RTS3T024	24VDC	1415898-1									
RTS3T048	48VDC	1-1415898-1									
RTS3T060	60VDC	1-1415898-2									
RTS3TA05	With test tab, 23.6mm high			Bistable, 1 coil	5VDC		1-1415898-5				
RTS3TA06				6VDC	3-1415898-1						
RTS3TA12				12VDC	1415898-2						
RTS3TF03				Bistable, 2 coils	3VDC		1415898-4				
RTS3TF12				12VDC	1415898-5						
RTS3TF24				24VDC	1415898-6						
RTT3TA12				Bistable, 1 coil	12VDC		1415898-7				
RTT3TF24				Bistable, 2 coils	24VDC		1-1415898-0				
RTS3L012WG				Without test tab, 15.7 mm high	1form A (NO) contact		AgSnO <sub>2</sub>	Monostable	12VDC	IEC60335-1 compliant	2-1415898-7
RTS3L024WG									24VDC		5-1415898-1
RTS3T012WG	12VDC	5-1415898-6									
RTS3TA24WG	Bistable 1 coil	24VDC	4-1415898-7								

This list represents the most common types and does not show all variants covered by this datasheet.  
Other types on request.